

1 . Features

- Input Filter With Internal Capacitor
- SIL and DIL Package
- Low Ripple And Noise
- Input / Output Isolation 1K Vdc
- 100% Burn-In
- Industry Standard Pinout
- Custom Design Available
- Net Weight : 3.0g / 3.7 g Typical
- RoHS Converter Certified By SGS
- Safety Approval : EN60950-1

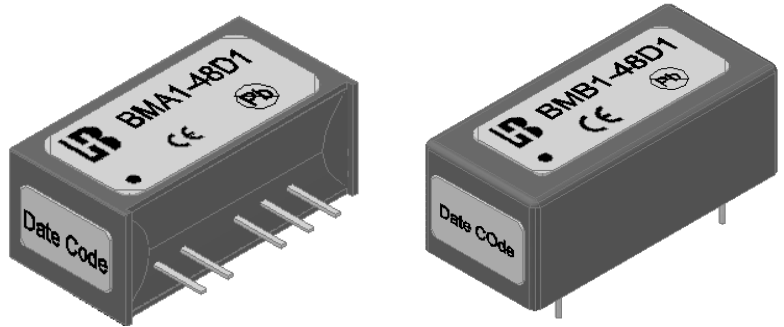

2 . Model Selection Guide

(Specifications typical at Ta= +25°C, Nominal input voltage, Rated output current unless otherwise noted)

Model No.	Input Voltage (Vdc)	Output Voltage (Vdc)	Output Current (mA) Max	Input Current @No Load (mA) Typ.	Input Current @Max. Load (mA) Typ.	Output Ripple (mV) Max.	Load Regulation (%) Max.	Efficiency (%)Typ.
1) Dual Output SIL Package Style								
BMA1-48D1	48	± 5	± 100	6	31	60	±10	72
BMA1-48DA		±9	± 56	5.5	30	80	±10	74
BMA1-48D2		± 12	± 42	5.5	30	100	±10	73
BMA1-48D3		± 15	± 34	5.5	30	120	±10	74
2) Dual Output DIL Package Style								
BMB1-48D1	48	± 5	± 100	6	31	60	±10	72
BMB1-48DA		± 9	± 56	5.5	30	80	±10	74
BMB1-48D2		± 12	± 42	5.5	30	100	±10	73
BMB1-48D3		± 15	± 34	5.5	30	120	±10	74

3 . Absolute Maximum Ratings

(Exceeding these values may damage the module. These are not continuous operating ratings)

Parameter	Condition	Min.	Typ.	Max.	Unit
Input Absolute Voltage Range	48V nominal Input	-0.7	48	60	Vdc
Max. Output Power		---	---	1	W
Output Short Circuit Duration		---	---	1.0	Second
Operation Temperature(Ambient Temperature)	Output Full Load	-40	---	+85	°C
Storage Temperature		-55	---	+105	



4 . Nominal Input/Output Electrical Specifications

(Specifications typical at Ta= +25°C ,Nominal input voltage, Rated output current unless otherwise noted)

Parameter	Condition	Min.	Typ.	Max.	Unit
Input Voltage Range	48V nominal Input	43.2	48	52.8	Vdc
Output Voltage Accuracy	Nominal Input	---	---	± 5.0	%
Load Regulation(10% load to full load)		---	---	± 10	
Voltage Balance (Dual Outputs)		---	---	± 1.0	
Unbalanced load 10% to 100% full load		---	---	±15	
Switching Frequency		---	100	---	KHz
Temperature Coefficient	---	± 0.01	± 0.02	%/ °C	
Isolation Voltage	60 Second / 0.5 mA	1000	---	---	Vdc
Isolation Resistance	500 Vdc	1000	---	---	MΩ
Isolation Capacitance	1KHz / 250mV rms	---	30	---	pF
Max. Line Regulation (Per 1.0 % change in input change)	---	---	---	1.3	%

5 . General Specification

Parameter	Specification	Condition
Isolation Voltage	1000 Vdc	Test Duration 60 Seconds / 0.5 mA
Isolation Resistance	1000 MΩ Min.	@ 500 Vdc
Operating Temperature (1)	-40°C ~ +85°C	@ Ambient Temperature With Natural Convection
Operating Temperature (2)	-40°C ~ +95°C	@ Case Surface Temperature
Storage Temperature	-55°C ~ +105°C	---
Humidity	Up To 90 %	---
Cooling	Free Air Convection	---
Case Type	Plastic	---

6. Ordering Information

7 . Power Derating Curve

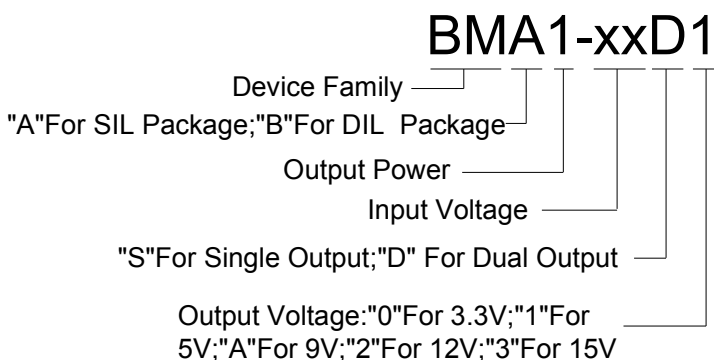

Temperature derating graph

Temperature Derating Graph

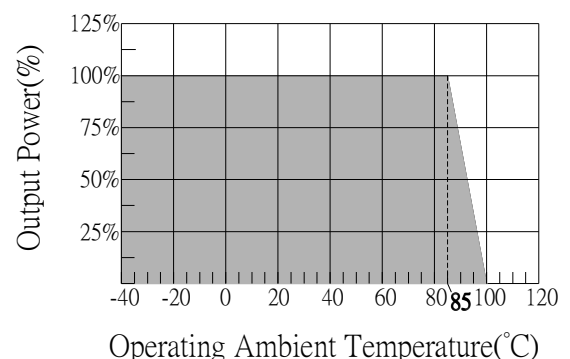

Bothhand Enterprise Inc.

www.bothhand.com.tw

E-mail: Sales@bothhand.com.tw

8 . Mechanical Dimension

SIL Package Style

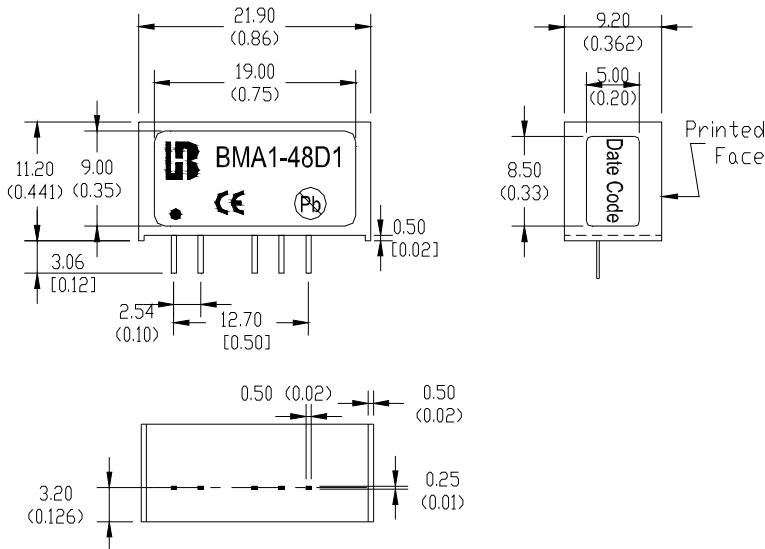

Pin	1K Vdc-Dual Output
1	+Vin
2	-Vin
3	No Pin
4	-Vo
5	Common
6	+Vo

Units : mm (inch)

Tolerance : 0.xx ± 0.25(0.xx ± 0.01)

DIL Package Style

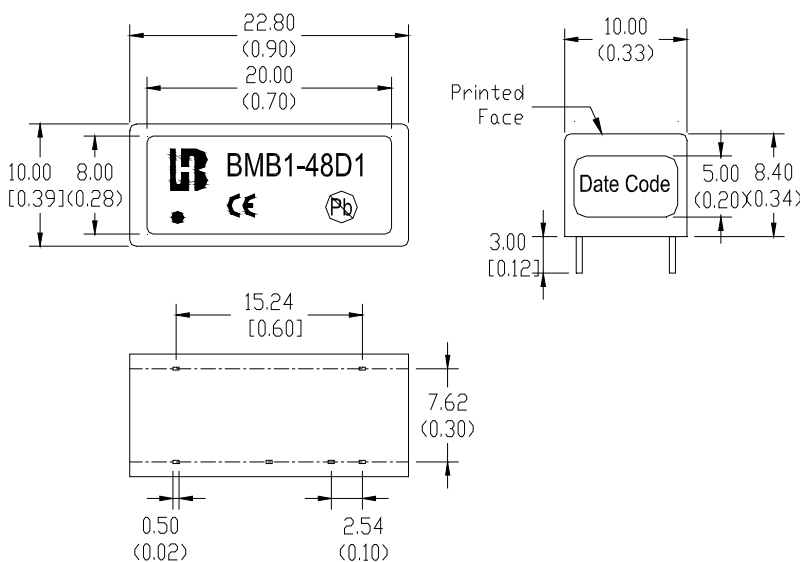

Pin	1K Vdc-Dual Output		Pin
1	-Vin	+Vin	14
2	No Pin	No Pin	13
3			12
4		-Vo	11
5		No Pin	10
6		+Vo	9
7	NC	common	8

Units : mm (inch)

Tolerance : 0.xx ± 0.25(0.xx ± 0.01)



Bothhand Enterprise Inc.

www.bothhand.com.tw

E-mail: Sales@bothhand.com.tw

9. Package

SIL Package Style

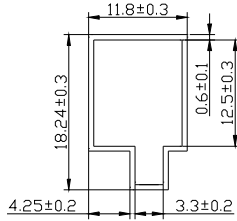

TUBE MECHANICAL DIMENSION

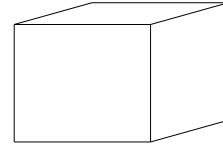
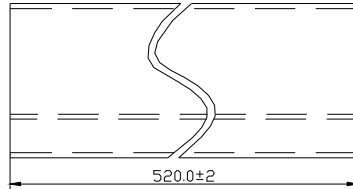

INNER CARTON:565*115*117

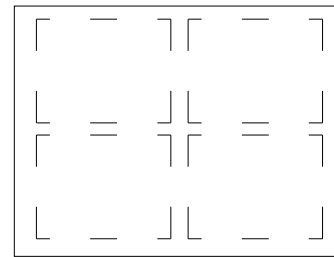
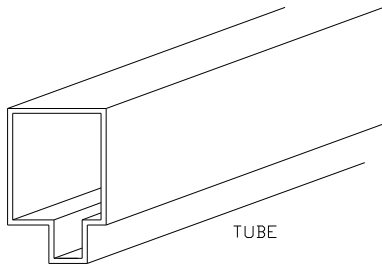

EXPORT CARTON:580*255*265

1. TUBE=23PCS
2. INNER CARTON=45 TUBE=45*23=1035PCS
3. EXPORT CARTON=4 INNER CARTON=4*1035=4140PCS

DIL Package Style

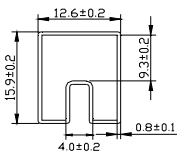

TUBE MECHANICAL DIMENSION

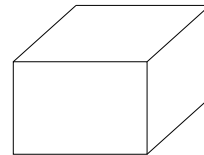
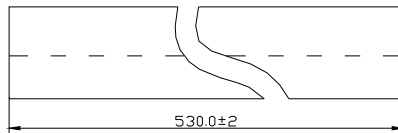

INNER CARTON:575*170*87

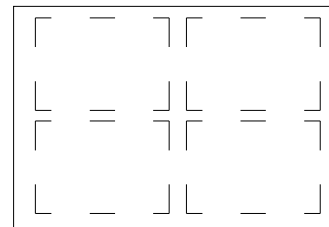
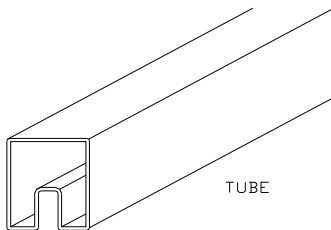

EXPORT CARTON:583*380*210

1. TUBE=22PCS
2. INNER CARTON=50 TUBE=50*22=1100PCS
3. EXPORT CARTON=4 INNER CARTON=4*1100=4400PCS

